

[www.oogvoorkeurenslijl.nl](http://www.oogvoorkeurenslijl.nl)

# Samen aan de slag!

1003 Annita (winterjas)

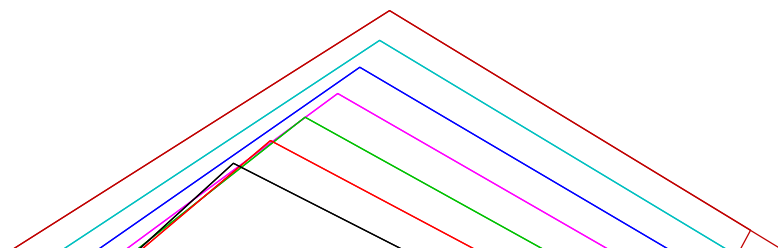

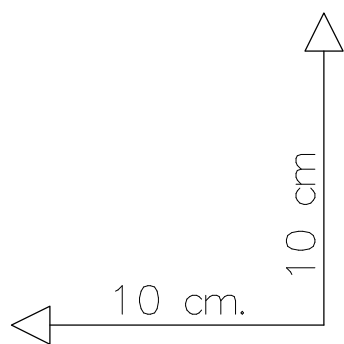
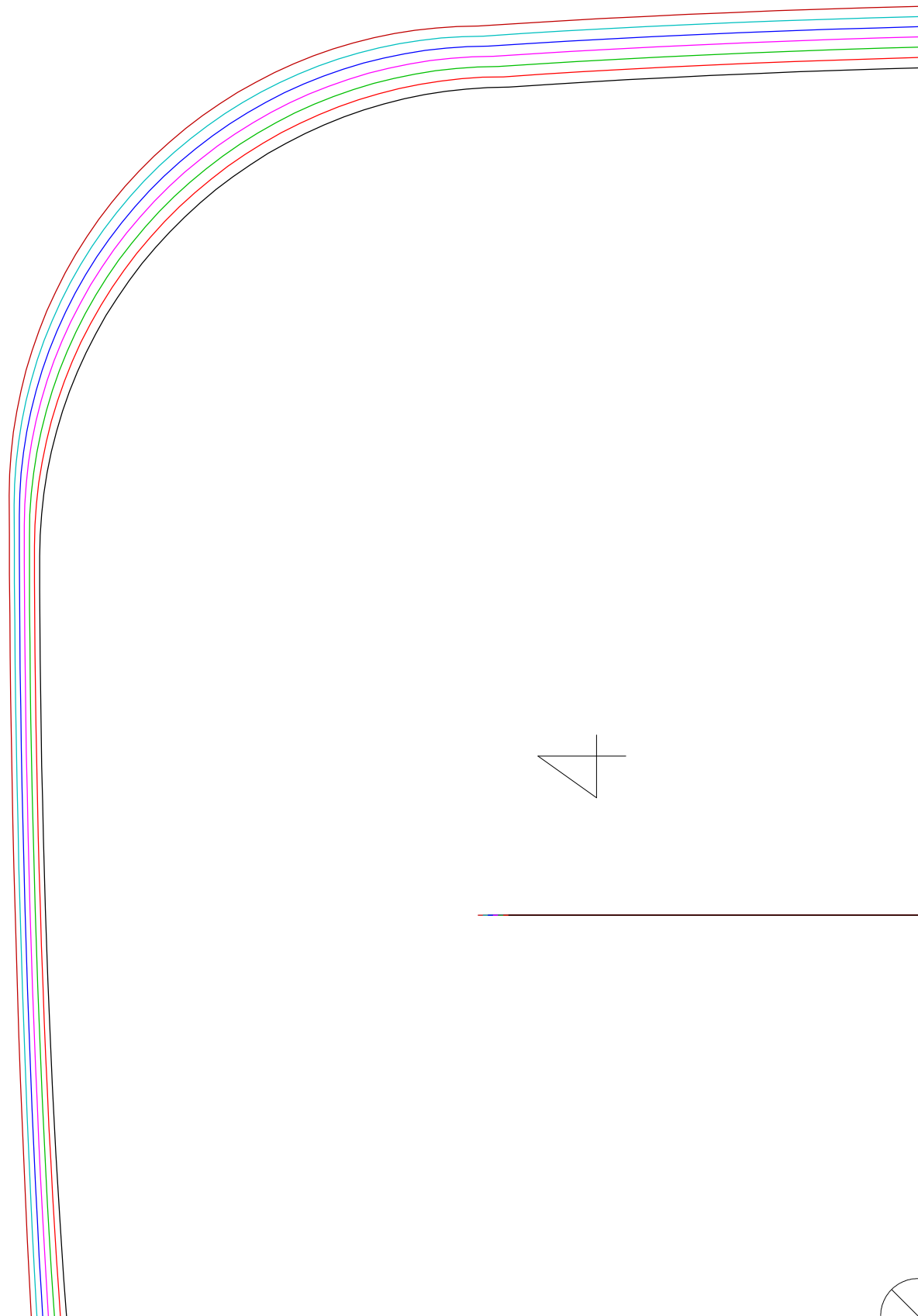

draadrichting capuchon (2x)

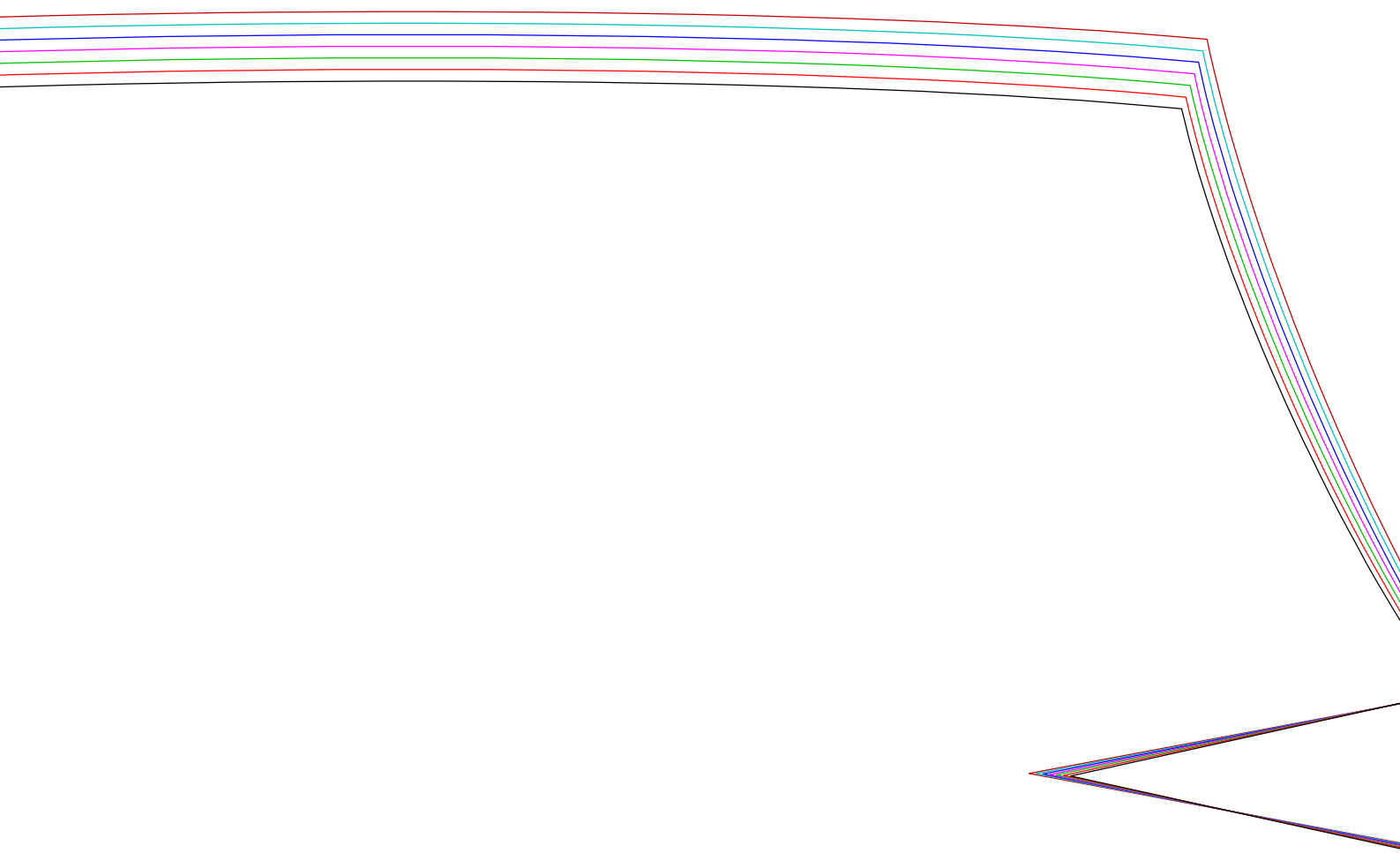





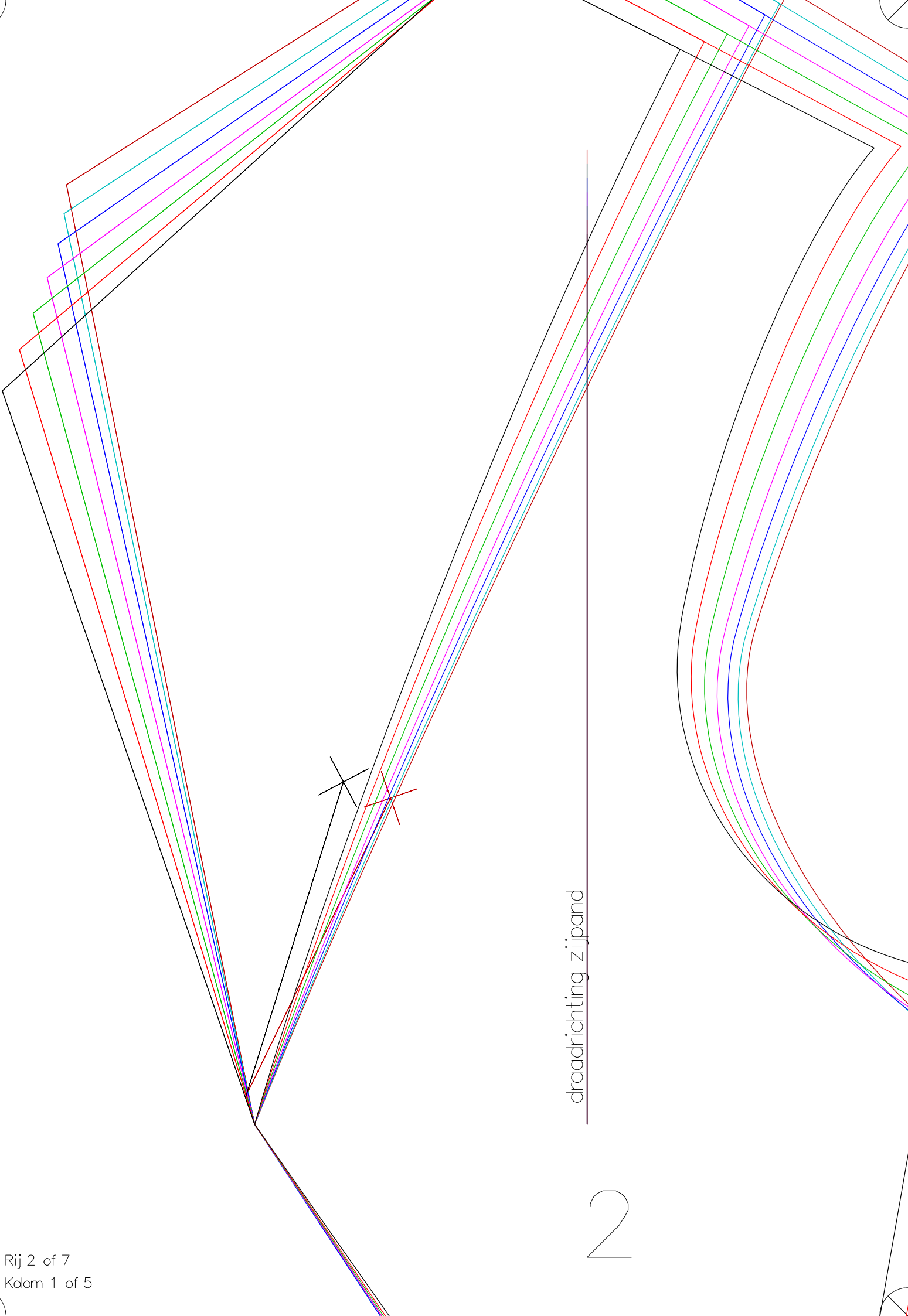

draadrichting zijpand

2

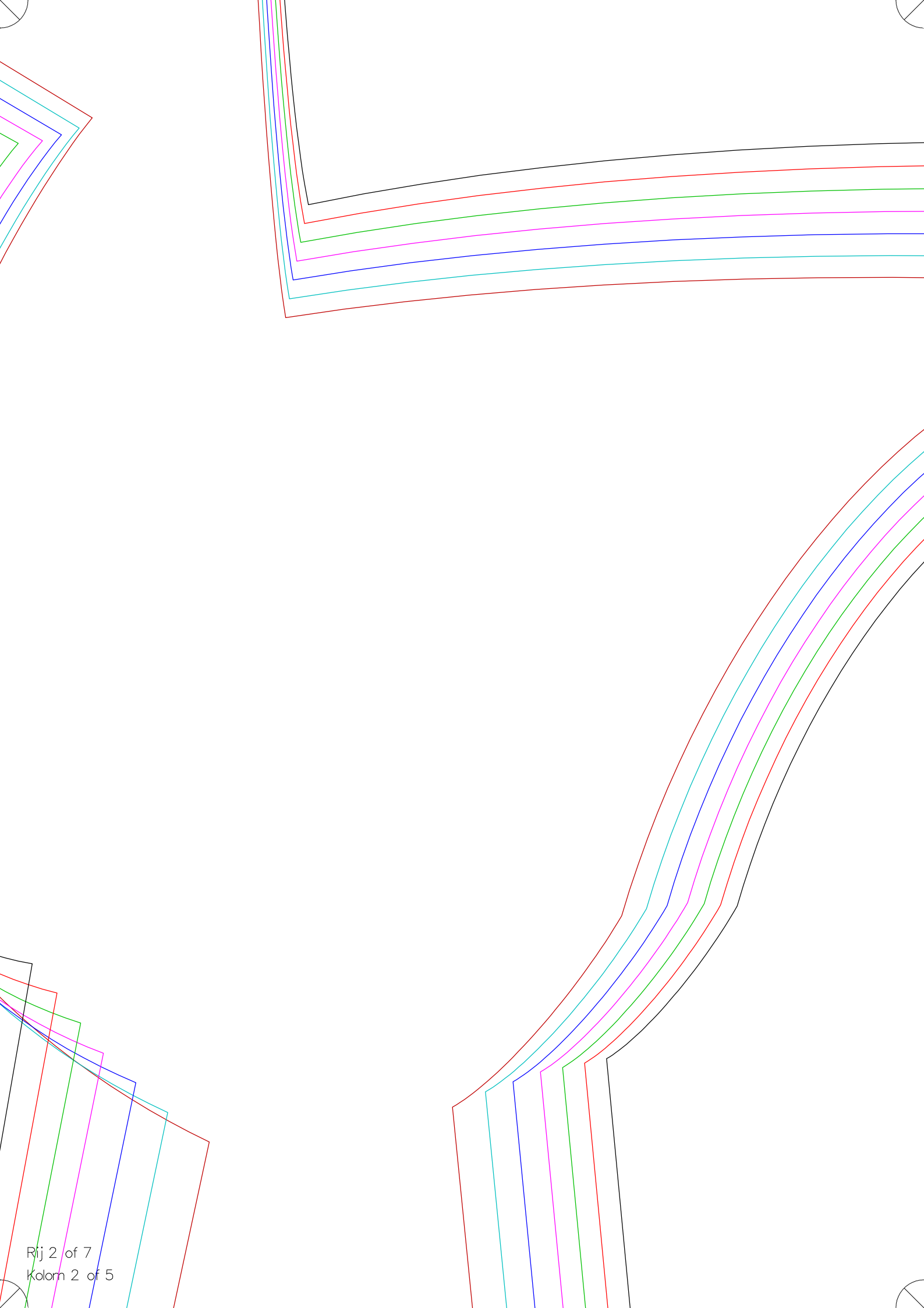

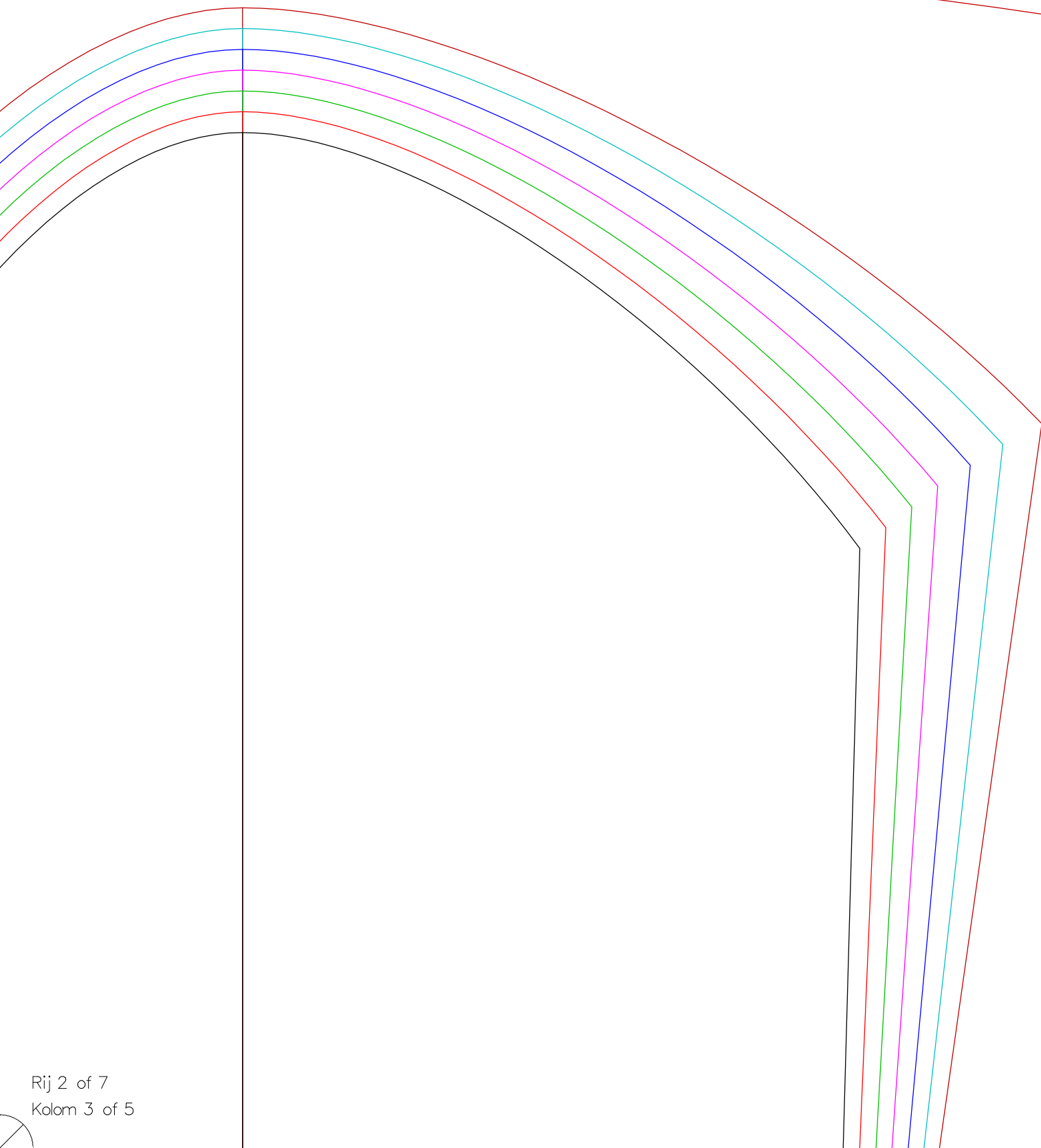
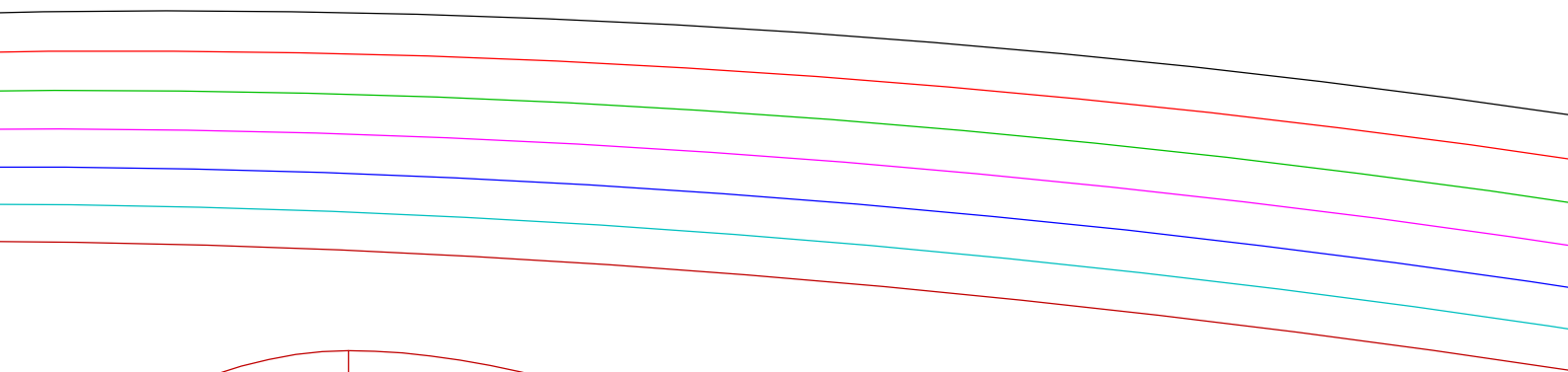



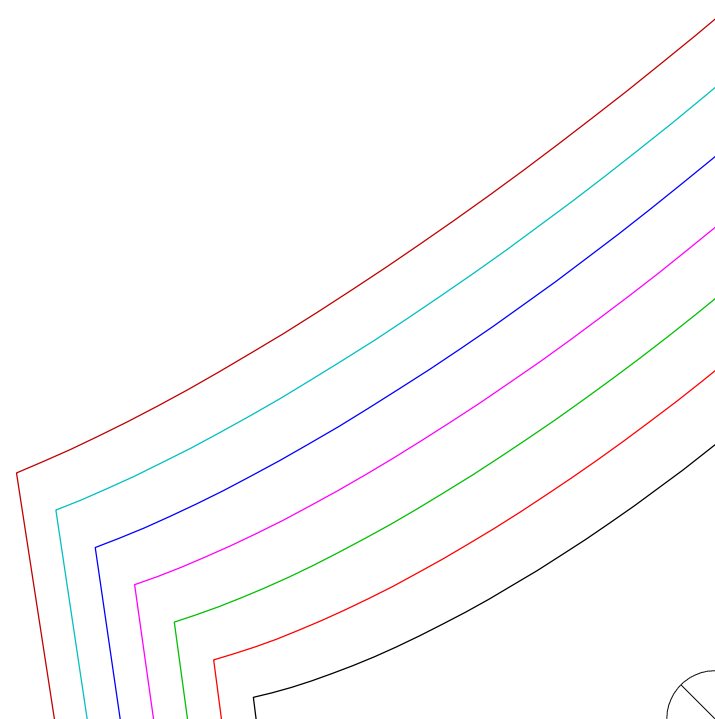
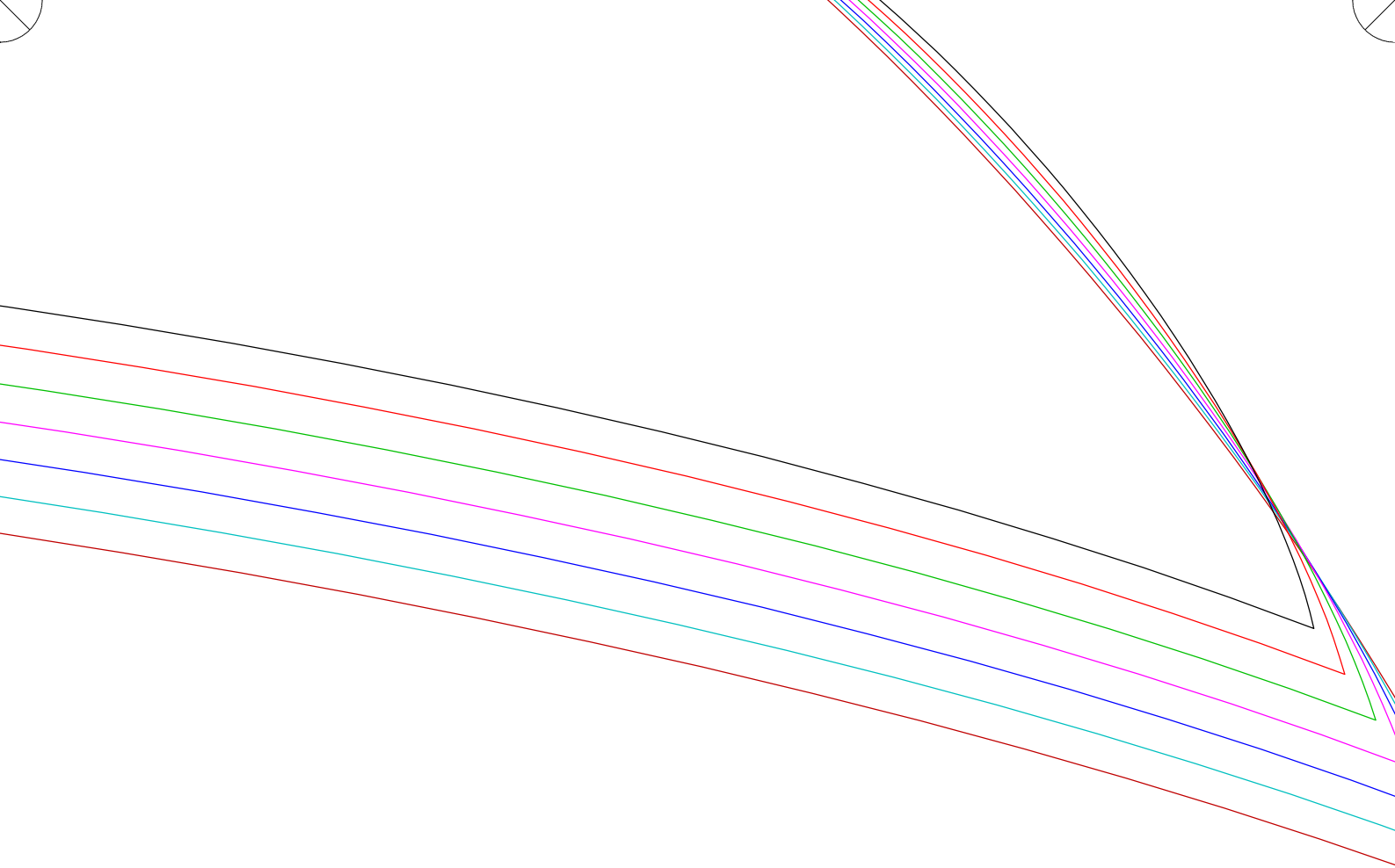

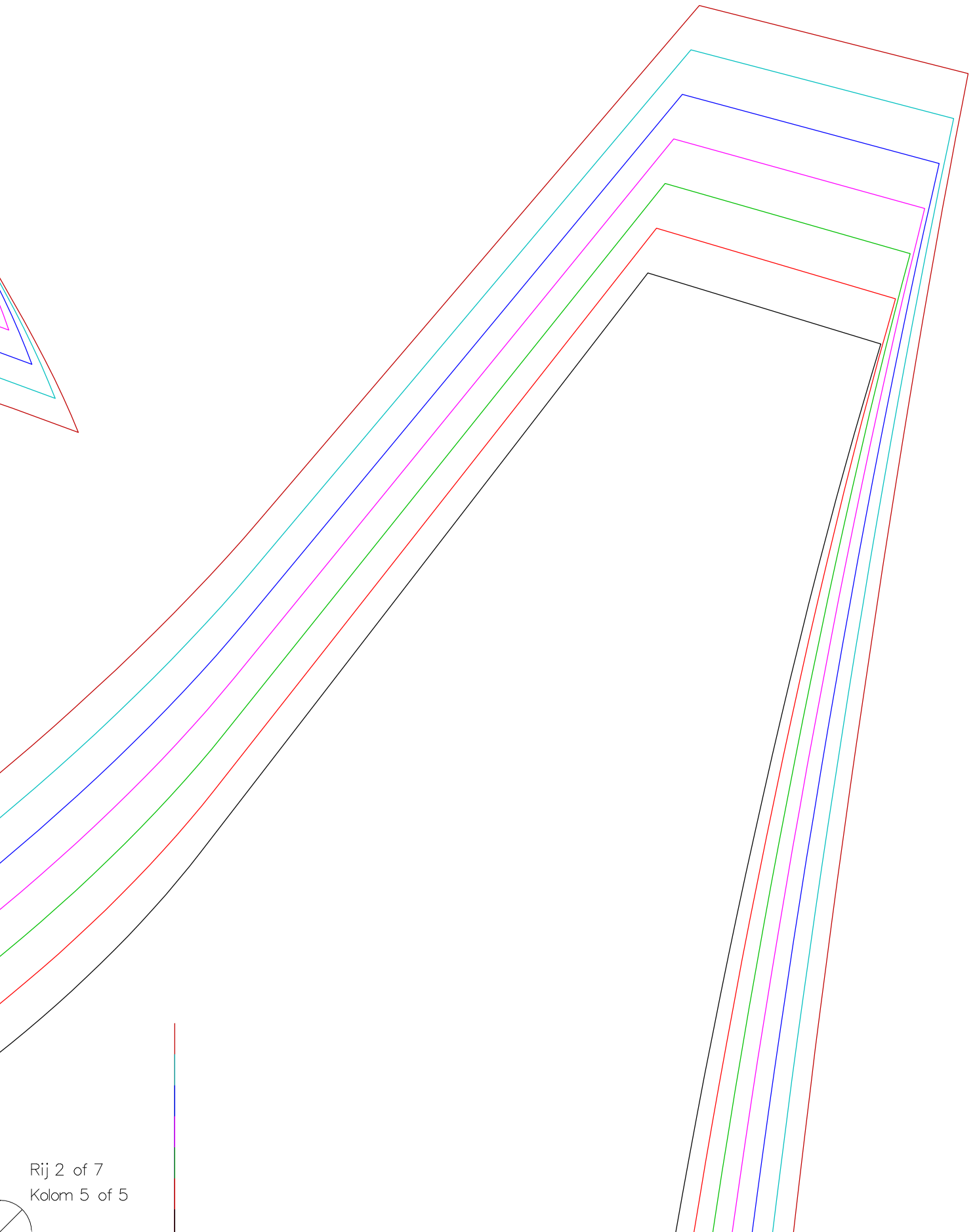

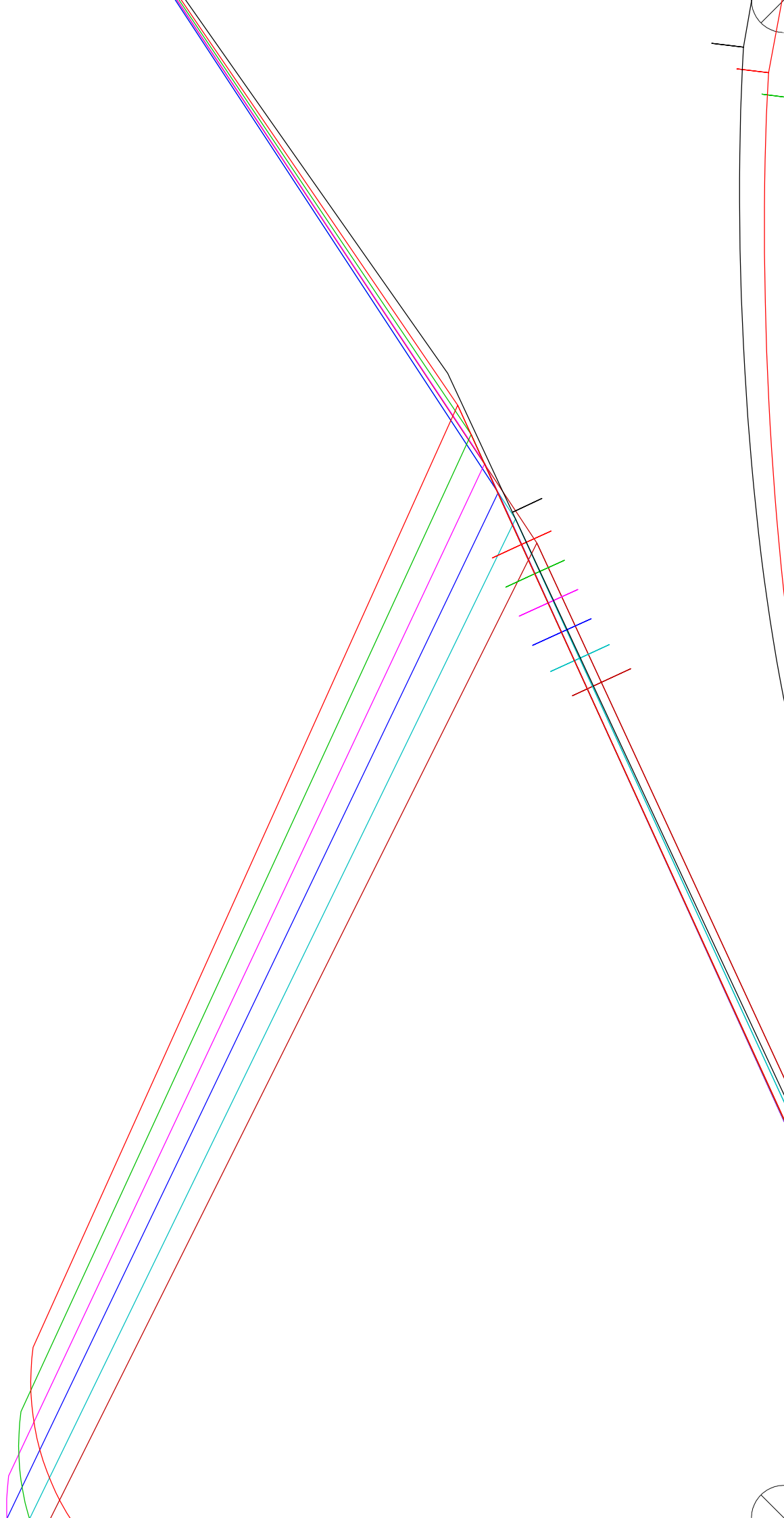

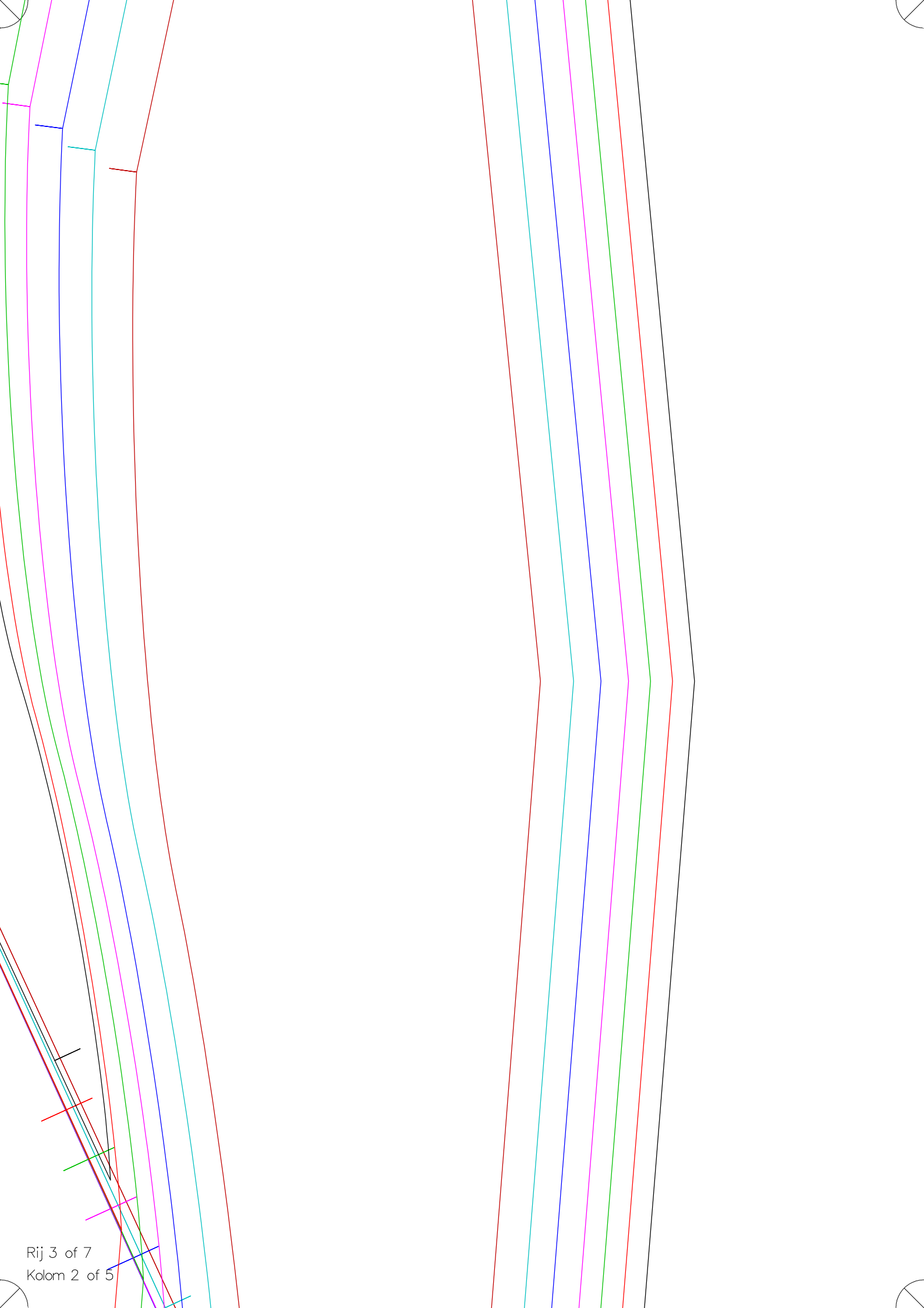

Rij 3 of 7  
Kolom 2 of 5

draadrichting\_bovenmouw

6

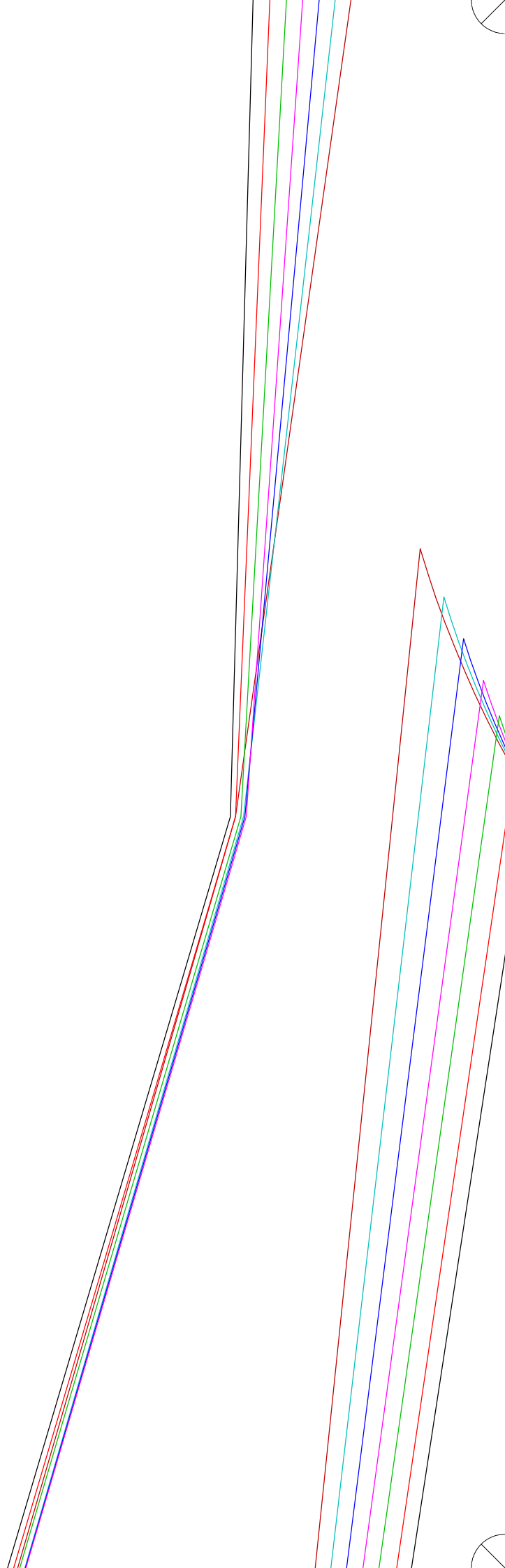

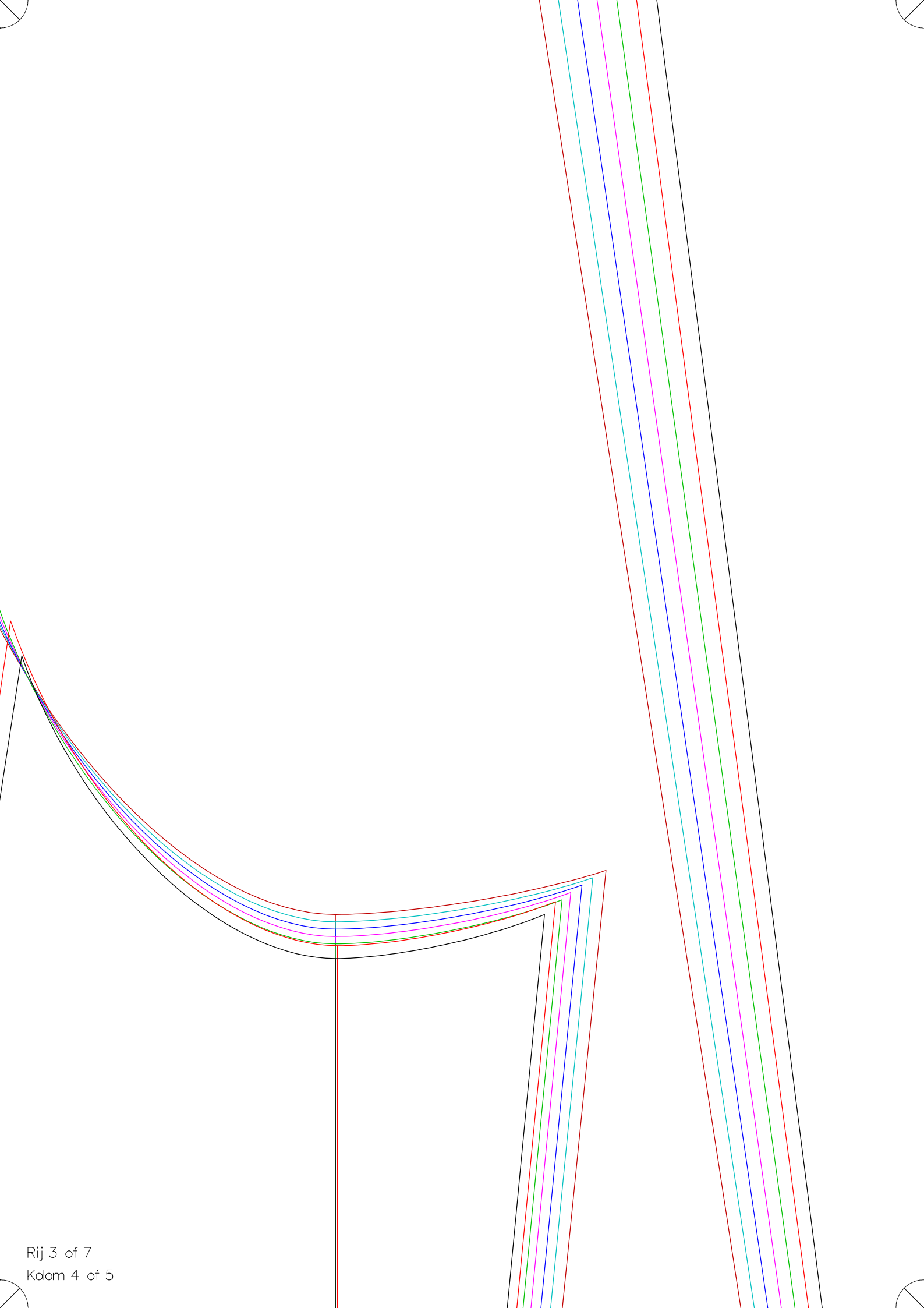



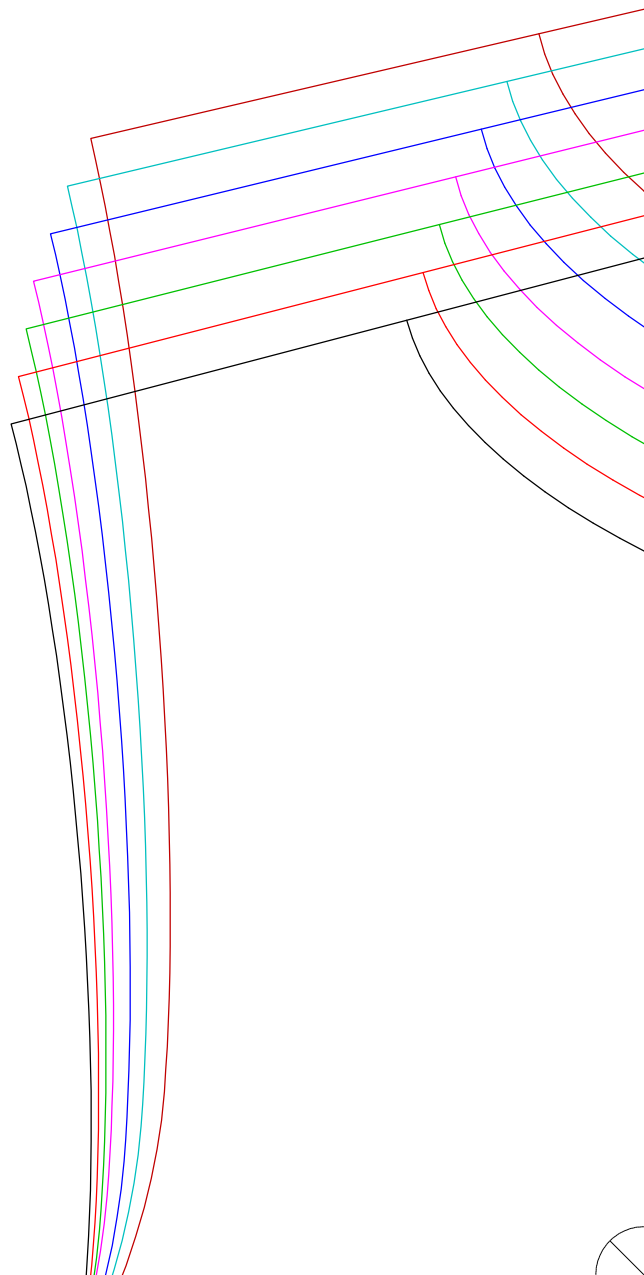
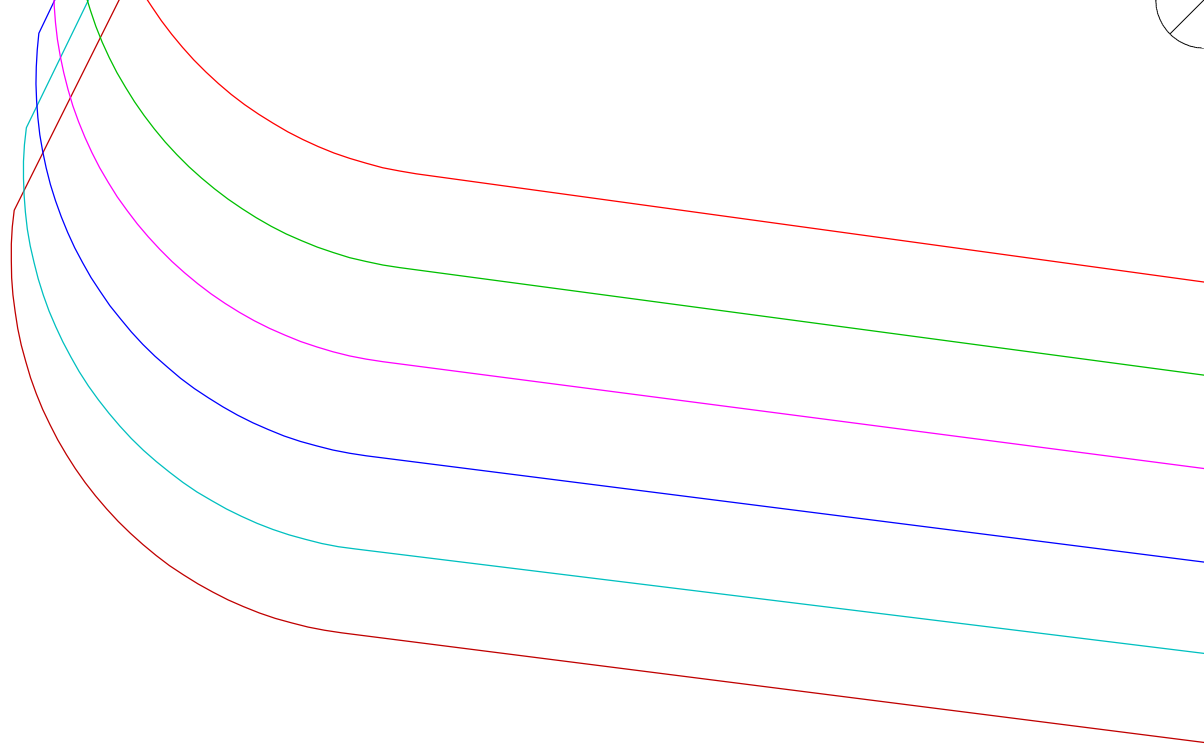



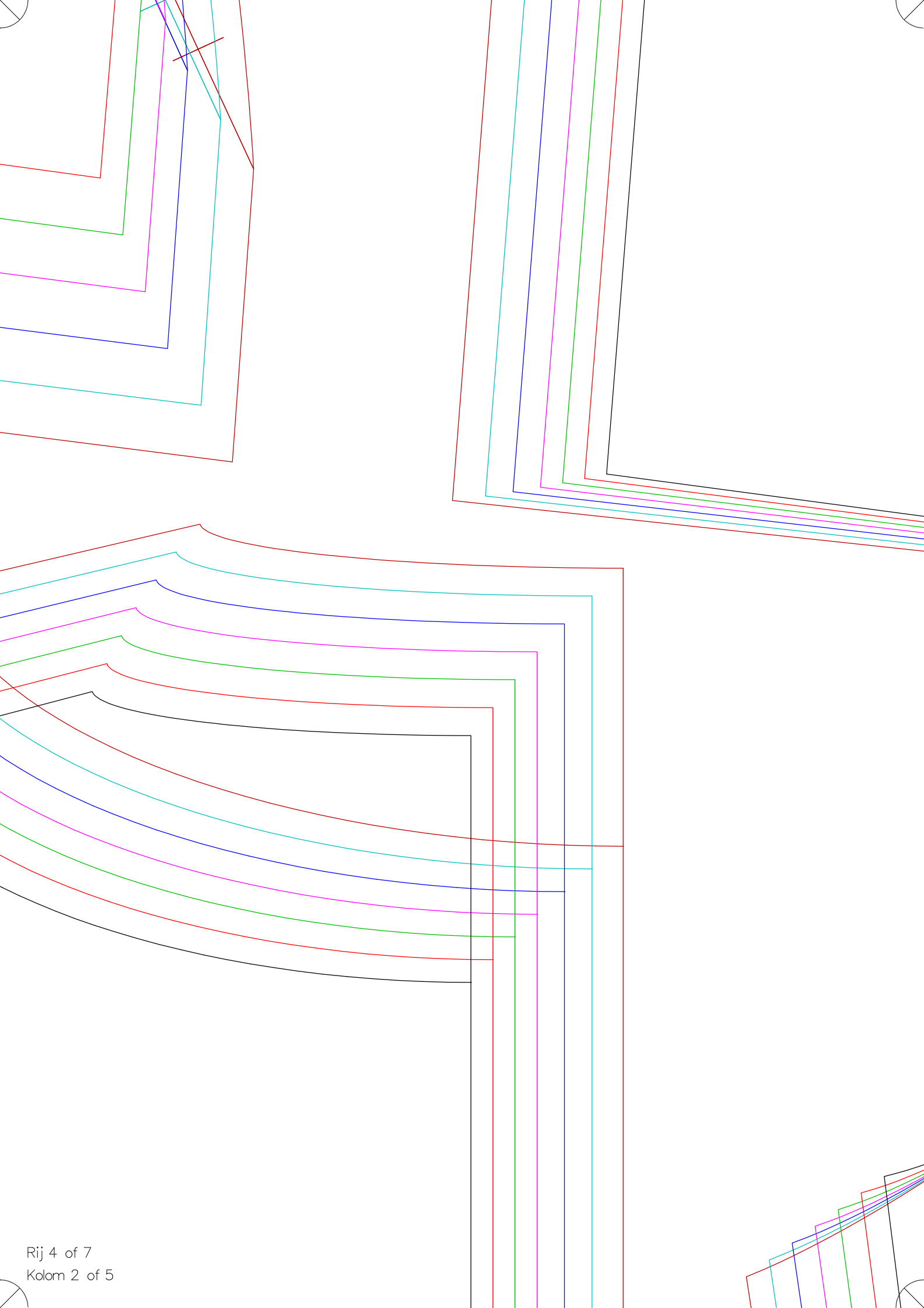

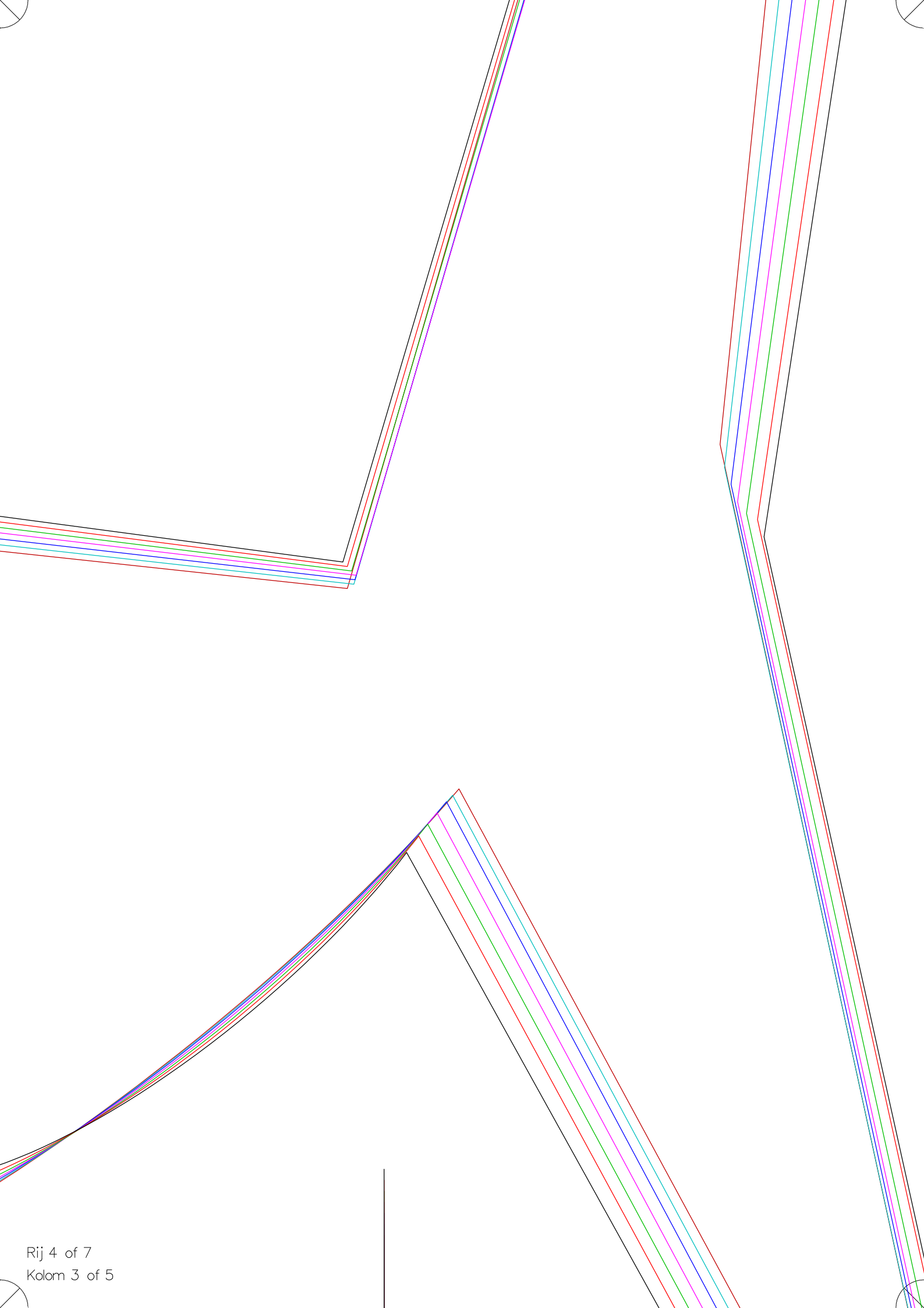

7

draadrichting ondermouw

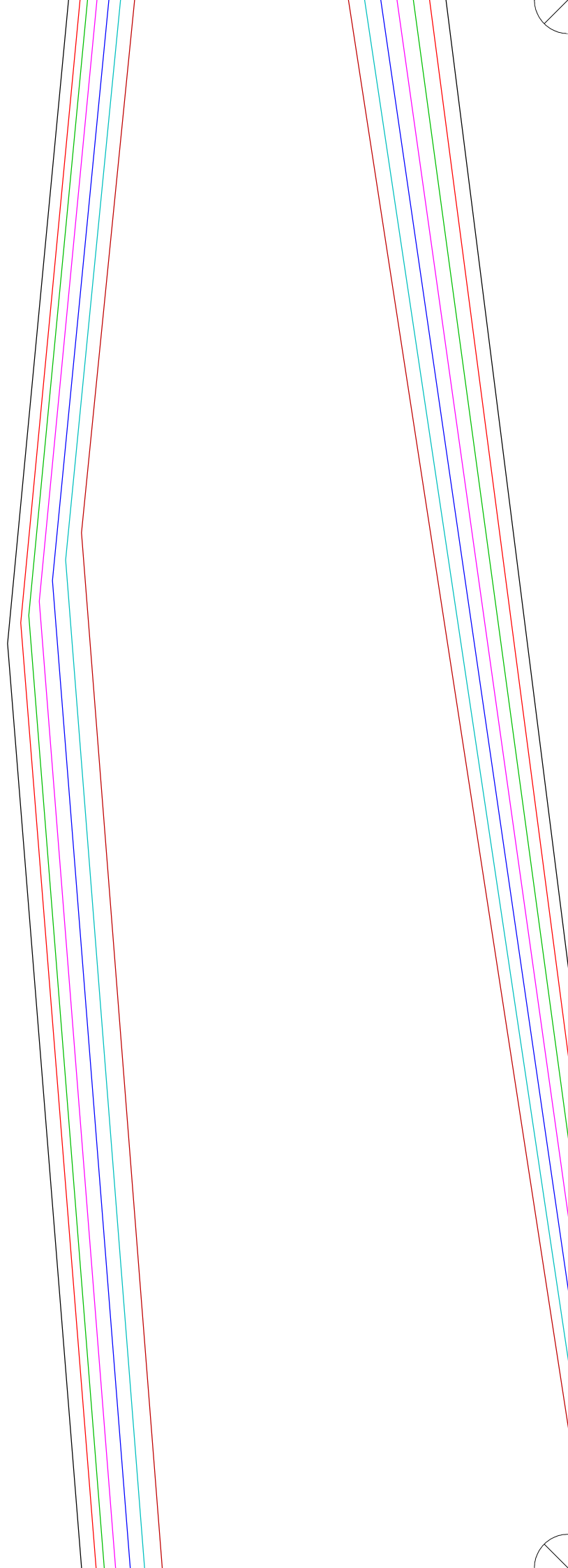

draadrichting – middenvoor – beleg

5

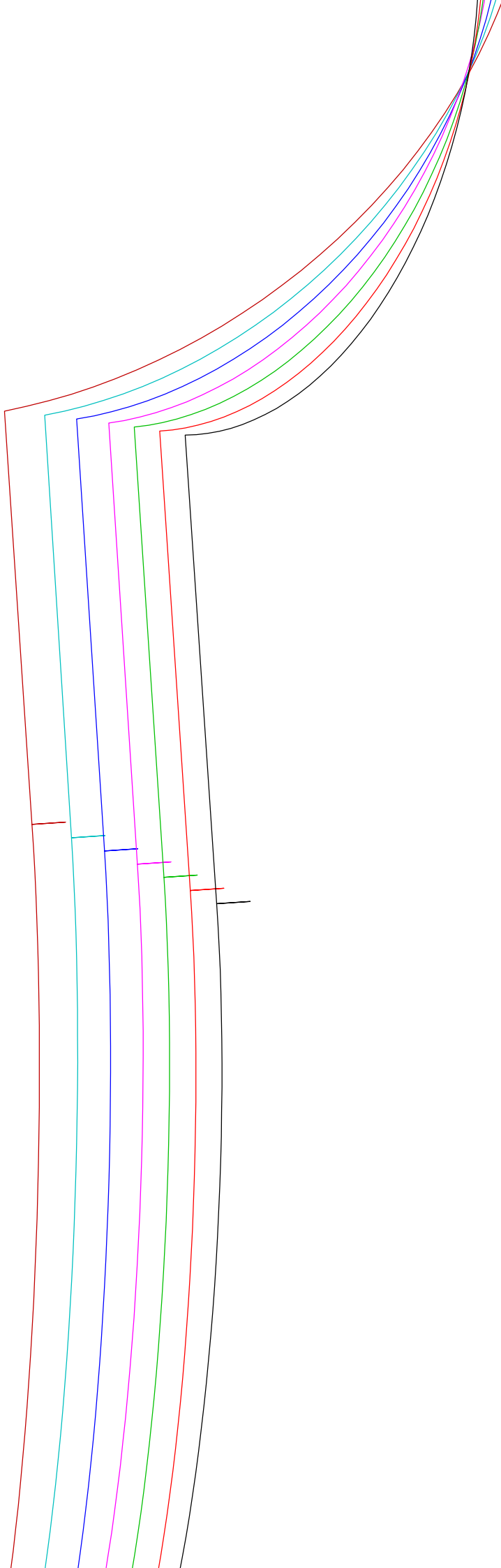



oor – voorpand

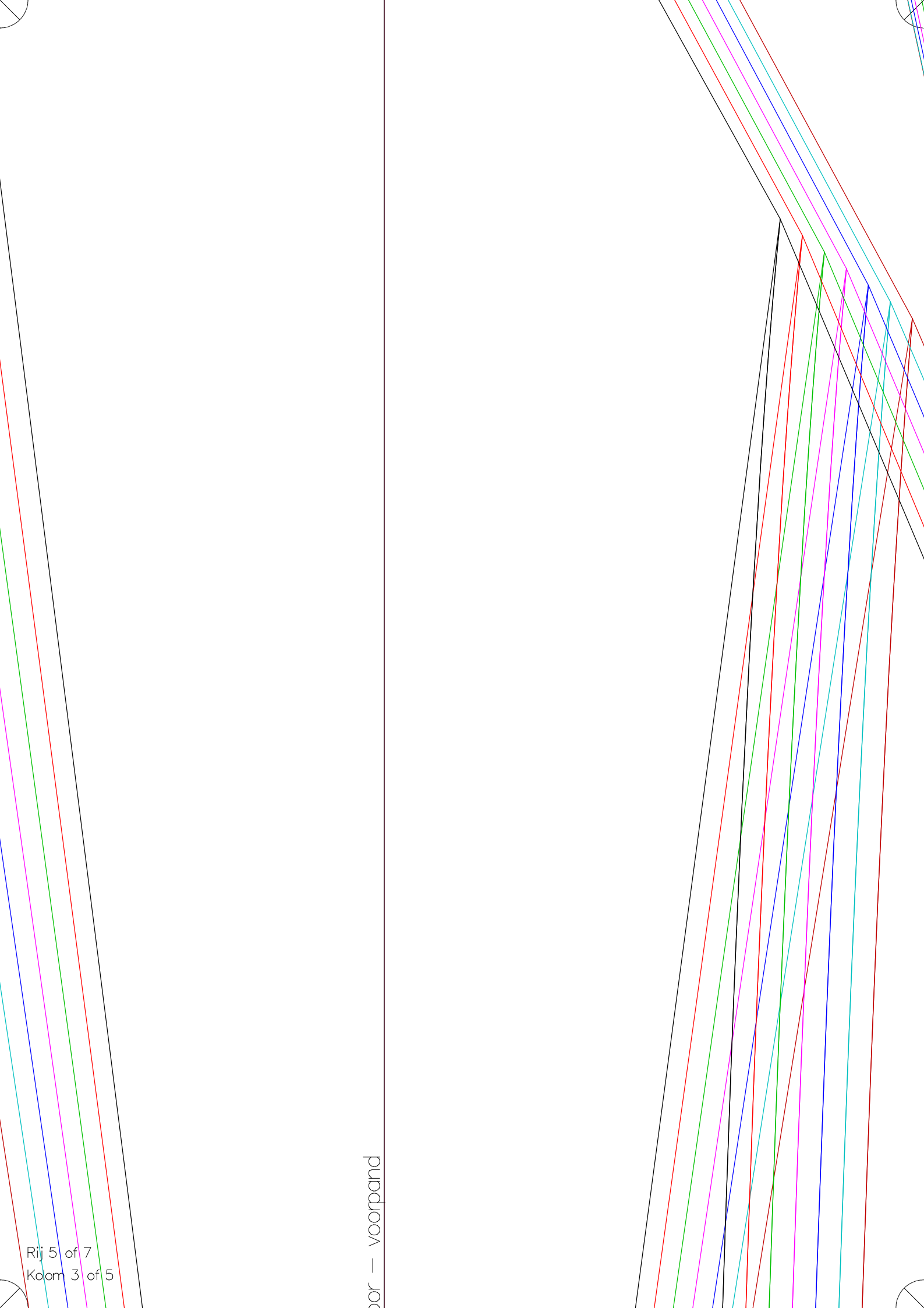

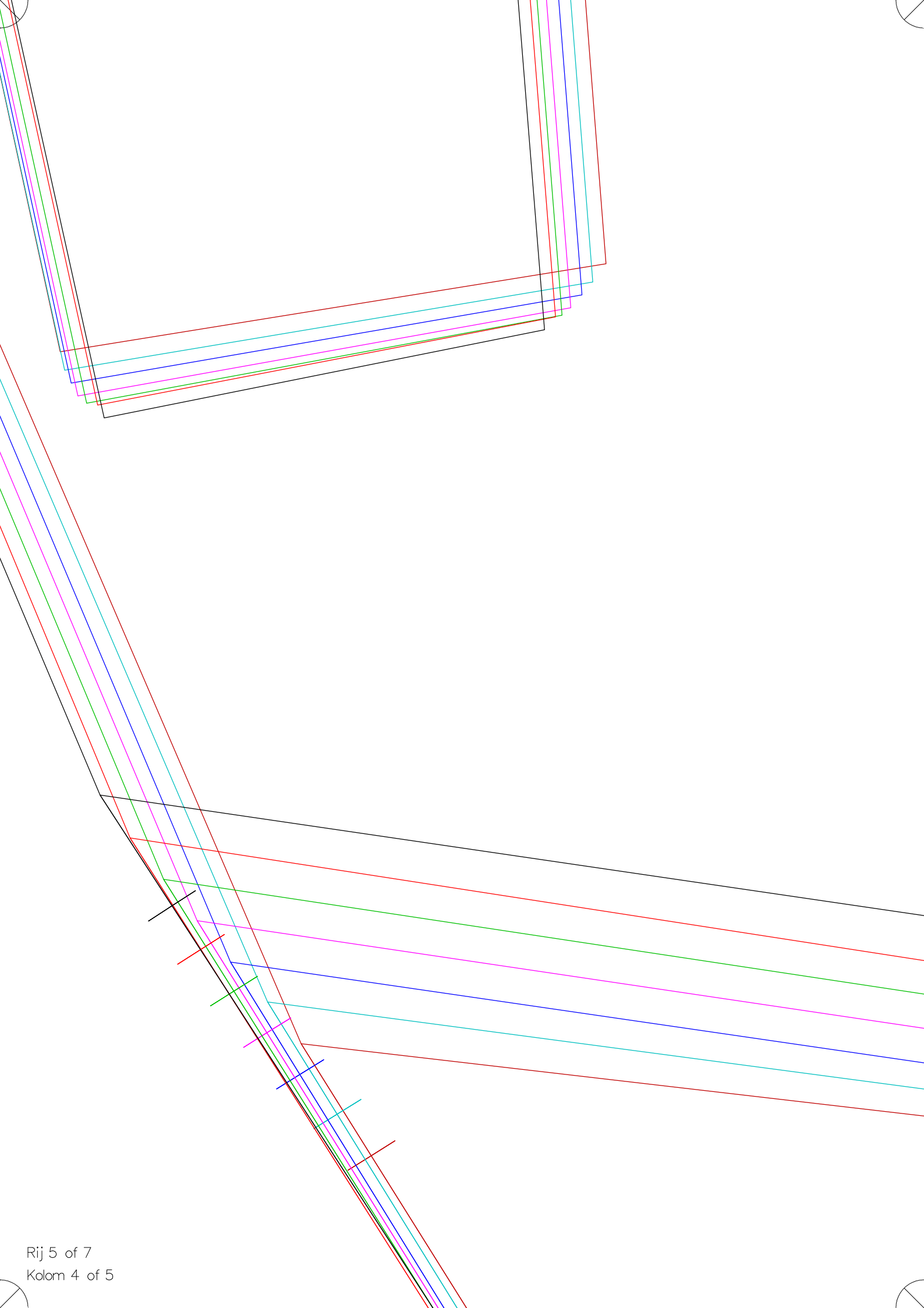



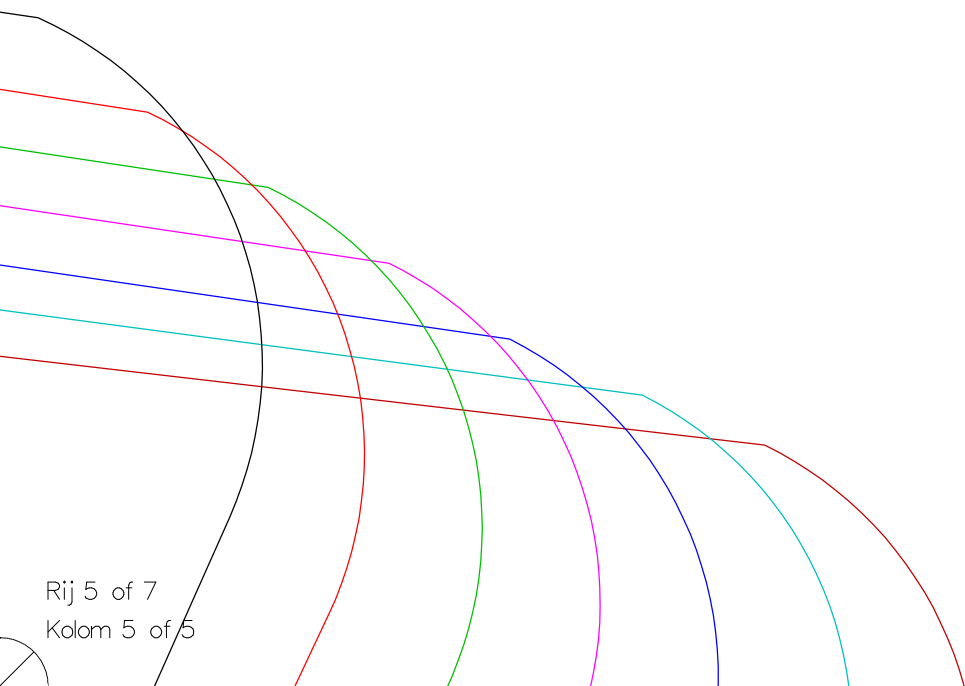
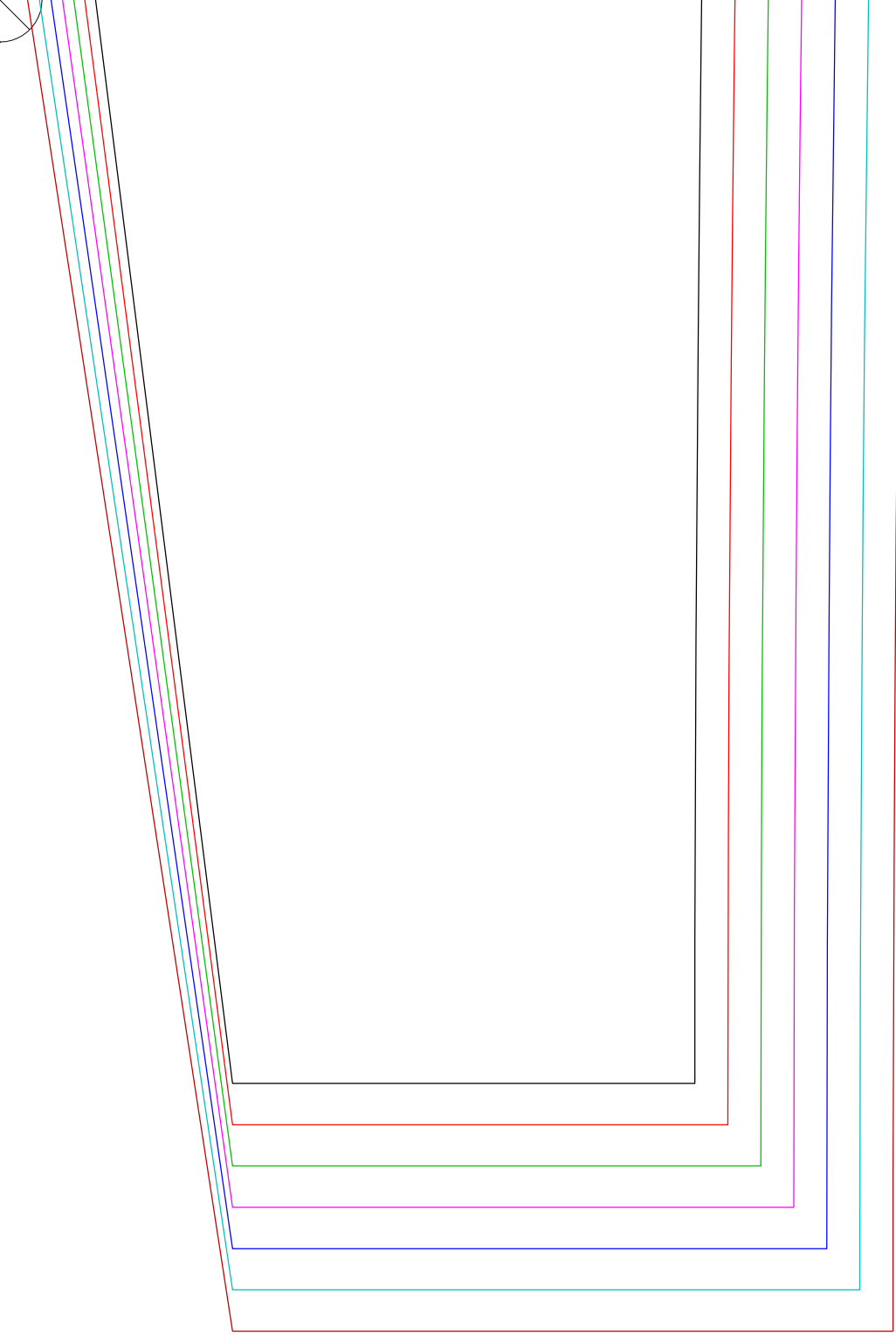

Rij 5 of 7  
Kolom 5 of 5

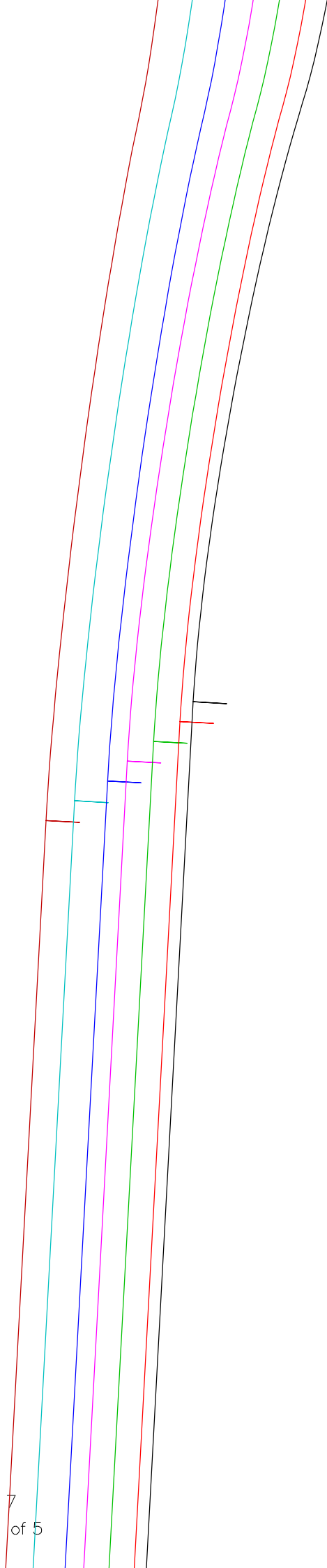

3

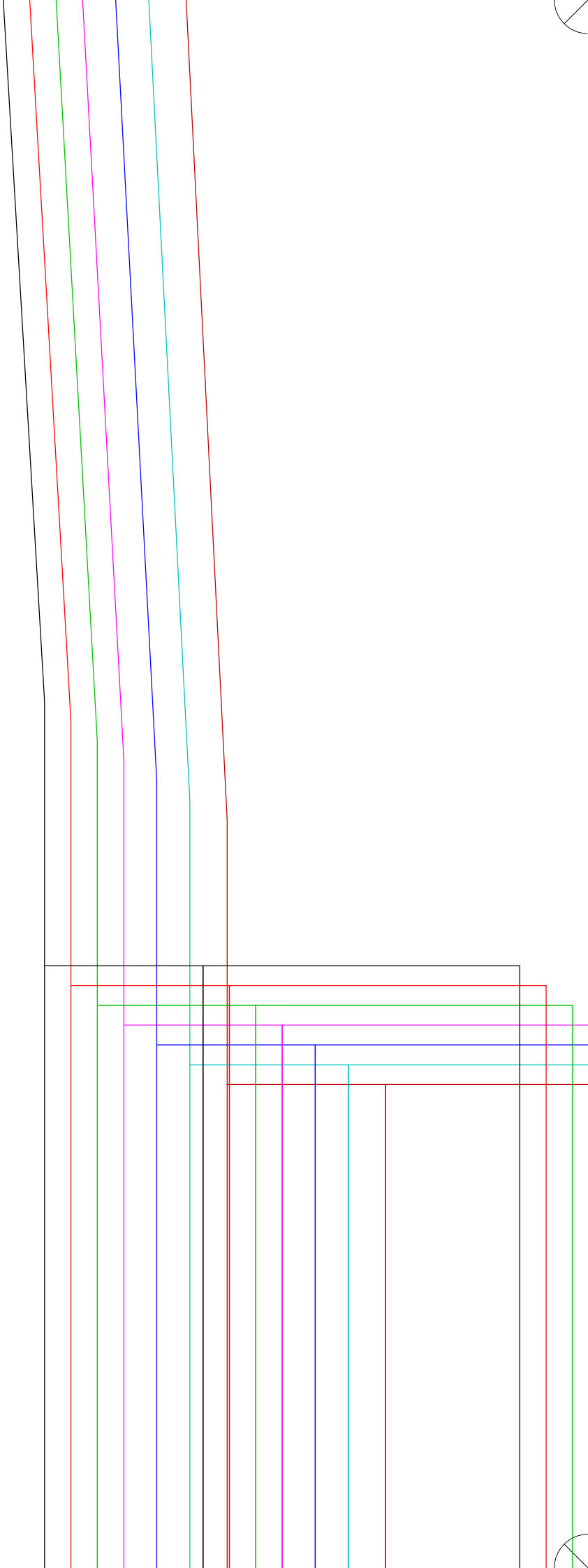

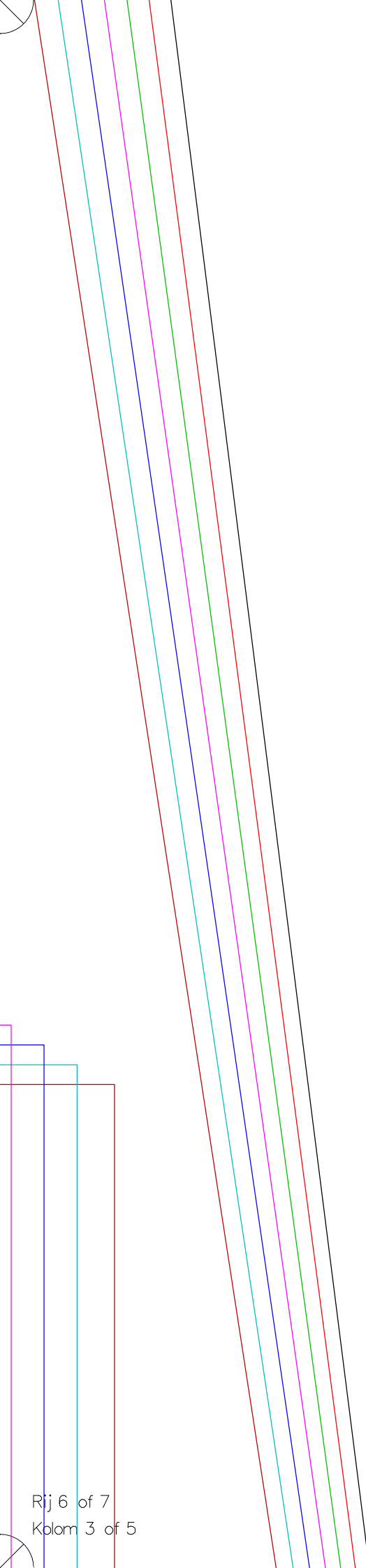

draadrichting – middenve



1

